



AGA eR7i User Guide

PLEASE READ THESE INSTRUCTIONS
BEFORE USING THIS APPLIANCE.



LPRT 518049
07/24 EOPI 518051



My AGA Details

AGA eR7i

Serial No _____

AGA Service No _____

Date of Installation _____

For further advice or information contact your local AGA specialist.

With a policy of continuous product improvement, AGA Rangemaster reserves the right to change specifications and make modifications to the appliance described and illustrated at any time.

© AGA Rangemaster Limited 2023









AGA is a trading name of AGA Rangemaster Ltd. AGA brand names, words and logos are registered trademarks of the AGA Rangemaster Ltd, Meadow Lane, Long Eaton, Nottingham NG10 2GD

www.agaliving.com | www.agacookshop.co.uk

Contents

Warnings	4	Handset - A hand held control	48
Introduction	5	Screens	48
Overview of your AGA eR7i	6	Button operations	48
A brief description - AGA eR7i hotcupboard	8	Handset advice	49
Equipment supplied with your AGA eR7i	9	Communication/handshake (<i>pairing</i>)	50
AGA Utensils and Accessories	13	The date/time setting screen	52
Getting to know your AGA	13	Auto/events programme screen	54
How to use your AGA eR7i	14	Information (home) screen	56
Operating Cast Iron Hotplate	16	Batteries	58
Using the zones of the AGA eR7i	17	Induction care	59
Using the Induction Hob	21	AGA (Hotcupboard)	61
Cooking on your AGA eR7i, ovens overview	31	Caring & cleaning	62
The cast Roast & Bake heat storage oven & grill	31	Fitting & removal of the cast heat storage oven shelves	67
The cast Simmering heat storage oven	33	Fitting & removal of fan oven shelves	67
The cast Simmering heat storage oven - User Guidance	34	Servicing & warranty	68
The fan oven	35	Serial number	68
Cooking on your AGA eR7i	36	Health & safety	68
AGA eR7i ovens settings	37	Deep fat frying	69
Operating the AGA eR7i ovens	39		
Manual mode (<i>cast and fan ovens only</i>)	39		
Slumber mode (<i>cast ovens only</i>)	41		
Auto mode (<i>cast ovens only</i>)	43		
Auto Slumber (<i>cast ovens only</i>)	45		

Warnings

-  **WARNING:** The appliance and its accessible parts become hot during use. Care should be taken to avoid touching heating elements. Children less than 8 years of age should be kept away unless continuously supervised.
-  **WARNING:** The appliance can be used by children aged from 8 years and above and persons with reduced physical, sensory or mental capabilities or lack of experience and knowledge if they have been given supervision or instruction concerning use of the appliance in a safe way and understand the hazards involved. Children should not play with the appliance.
-  **WARNING:** Cleaning and user maintenance should not be made by children without supervision.
-  **WARNING:** Unattended cooking on a hob with fat or oil can be dangerous and may result in fire. NEVER try to extinguish a fire with water, but switch off the appliance and then cover flame e.g. with a lid or fire blanket.
-  **WARNING:** Danger of fire: DO NOT store items on the cooking surfaces.
-  **WARNING:** DO NOT operate this appliance with the doors open, as this can cause a lock-out
-  **WARNING:** If the glass-ceramic surface of the induction hob is cracked, switch off the appliance to avoid the possibility of electric shock.
-  **WARNING:** Metallic objects such as knives, forks, spoons and lids should not be placed on the hob surface since they can get hot.

Introduction

Your new AGA eR7i gives you everything you love about an AGA heat storage cooker, but with the ability to turn each cooking area on and off, and the added convenience of an induction hob, fan-assisted oven and touchscreen control to select from a range of cooking temperatures.

Made in the heart of Shropshire, your AGA cooker, like the generations of cookers before it, has been manufactured from cast iron. Traditional iron-making skills combined with industrial strength elements enable the ovens and hotplates to heat up rapidly, so you can have them all on, or just one.

The cooking excellence of the AGA cooker has been famous since its inception in the 1920's, and is renowned due to the indirect radiant heat that its cast iron emits rather than just air temperature. And, if you haven't found out already, you'll soon discover that food that is cooked this way retains its natural flavour and succulence, and simply just tastes better.

So grab a cup of tea, have a read, and prepare to dig into some of the tastiest dishes you're ever likely to make.

Overview of your AGA eR7i

- A. Induction unit
- B. Hotplate - Boil & Simmer
- C. Control panel
- D. Cast Roast & Bake heat storage oven & grill
- E. Fan oven
- F. Cast simmering heat storage oven

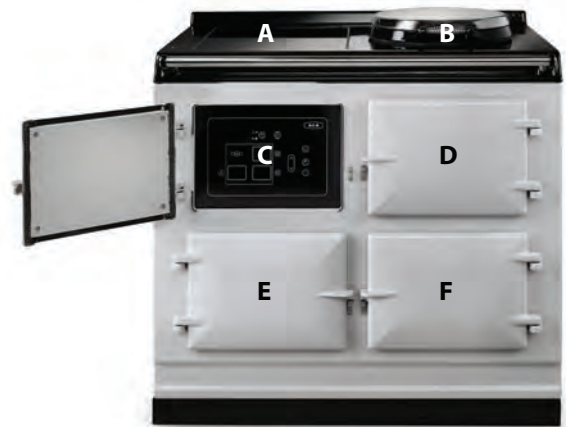

Hotplate

The hotplate has two different settings: the boiling setting being the hottest of the two and the simmering setting at a lower heat. Each hotplate is individually temperature controlled.

Boiling setting

Used for boiling, frying, griddling, stir-frying, making toast - indeed anything that requires a high heat. Green vegetables keep their colour when boiled quickly here or use a steamer over the saucepan to cook more than one vegetable at once.

Simmering setting

Used for recipes that require a lower heat such as, making sauces, scrambling eggs, heating milk, slow frying, simmering soups and root vegetables. In addition it can be cooked on directly as a form of griddle - invaluable for toasted sandwiches, quesadillas, drop scones, searing scallops and even a non-fat fried egg! Slow cooked toast can be made on the simmering plate, no need here to use the AGA toaster. (Use of Bako-Glide will protect the hotplate surface during 'direct on' cooking)

Induction hob

The 2-zone induction hob features automatic pan detection and is perfect for all types of hob cooking; from high temperature fast methods like stir frying, deep frying and rapid boiling (e.g. pasta) to gentle heat for delicate sauces and melting chocolate. The bridge modes can be used for large pans, griddles or a fish kettle.

Cast heat storage ovens

These ovens, made from cast iron, cook by a radiant heat, which is the secret of the cooking excellence for which the AGA cooker is renowned. An indirect radiant heat does not dry food out, so it retains its natural moisture and flavour.

The top cast iron oven/grill is ideal for cooking a range of foods with 9 pre-set cook settings giving flexibility to vary the oven temperature from cool to very hot. These settings are equivalent temperatures to gas marks; for baking B1 to B4, roasting from R6 to R9, and grilling on the grill setting G.

The lower cast iron simmering oven has a fixed temperature and offers long, slow cooking and develops flavours and makes the toughest meat tender. Its large capacity means several pans can be stacked here; soup, casserole, steamed rice, steamed vegetable and poached fruit all cooking simultaneously, without any danger of burning, leaving the hotplate free.

The cast ovens have the same capacity, (able to fit a 10kg (22lb) turkey) and the AGA heat-storage cooker techniques can be used such as stacking of saucepans in the simmering oven. You can also have the top cast oven on 'Slumber' mode, (the simmering oven is always at the same heat).

Fan oven

This oven offers a faster heat up for cooking a range of foods with 8 pre-set cook settings for baking B1 to B4, and roasting from R6 to R9.

A brief description - AGA eR7i hotcupboard



Equipment supplied with your AGA eR7i



Large Size Roasting Tin with Grill Rack

This is designed to slide onto the oven runners without the need for it to sit on an oven grid shelf. The roasting tin can be used with the grill rack, in its high position, for grilling at the top of the roasting oven. It can be used for roasting meat, or poultry with or without the grill rack. Large quantities of roast potatoes can be cooked in this tin. The roasting tin can also be employed for making large traybakes or cakes. The grill rack is useful on its own as a cake cooling rack. It can be used in top or bottom cast oven but not recommended for fan oven or hotplate use.



Half Size Roasting Tin and Grill Rack

This tin can be slid onto the oven runners width-ways or can sit on an oven grid shelf. The half size roasting tin can be used with the grill rack, in its high position, for grilling at the top of the roasting oven. It can be used for roasting smaller joints of meat, or poultry with or without the grill rack. Roast potatoes can be cooked in this tin. The roasting tin can also be employed for making traybakes or cakes. The grill rack is useful on its own as a cake cooling rack. It can be used in any oven but not recommended for hotplate use.



1 x Roasting Tin

This is designed to be used on the oven grid shelves. The roasting tin can be used for roasting meat or poultry. Large quantities of roast potatoes can be cooked in this tin.

The roasting tin can also be employed for making large traybakes or cakes. Can be used in any oven but not recommended for hotplate use.



Control Panel

This is situated behind the top left hand door. The control panel has a capacitive touch screen with LED indicators and character display to indicate which zone is activated and what setting is selected. An audible beep will confirm selection.



Handset

Your AGA eR7i cooker also comes with a handset which can be used to programme the cast ovens only. It displays the time, date and programme events. The hotplates work on Manual only.



1x Floor Grid

This grid is used on the floor of the cast ovens, in particular the roasting and simmering ovens to protect food needing over 30 minutes cooking from the intensity of the heat from the base element.



2x Cast Oven Grid Shelves

These are for inserting in each oven to provide a surface for dishes and tins which do not fit direct onto the oven runners. They can be used in any cast oven, as required. **“Fitting & removal of the cast heat storage oven shelves” page 67** on how to locate the oven shelves correctly.



2x Fan Oven Grid Shelves

These are for inserting in the fan oven to provide a surface for dishes, trays and tins during cooking. **“Fitting & removal of fan oven shelves” page 67** on how to locate the oven shelves correct.



1x Baking Sheet

This is designed specifically for use in the fan oven, placed directly on the grid shelf. It is the recommended size to use when cooking scones, biscuits, meringues or pastry items.



1x Baking Tray

This is designed to be used on the oven grid shelves.



Toaster

This is for toasting bread on the boiling plate. AGA toast is renowned for its excellence, crisp on the outside and soft in the centre. Take thick slices of bread and place in the AGA toaster - if the bread is very moist or very fresh, heat the toaster beforehand to prevent sticking - lift the boiling plate insulated cover and place the toaster direct onto the plate with the handle at an angle from the handle of the cover.

Close the cover and wait for the bread to toast one side - this will take 1-2 minutes dependent upon the variety of bread - open the cover and turn the toaster over and repeat the process to toast the other side. The toaster can also be used for heating pitta bread, toasting teacakes and as a cake cooling rack.



Wire Brush

This is for cleaning the raw cast iron hotplate surfaces, keeping them clear of crumbs and burnt on debris - which would otherwise affect the boiling performance of pans and the kettle. Use on the hotplates and the cast ovens only. Take care not to touch the enamel surfaces as the wire brush will scratch the finish. Do not use in the fan oven.



AGA Utensils and Accessories

To get the very best performance from your cooker we recommend AGA saucepans with the thick tri-core bases and stacking lids so that the maximum use of oven space is made and an AGA kettle for boiling water. AGA Accessories can be viewed at your AGA Specialist or online at www.agacookshop.co.uk



Getting to know your AGA

If you have not already seen a demonstration, ask your AGA Specialist for details. A demonstration will show you how to get the best from your new AGA and will give you hints and tips. You will also see a selection of AGA utensils and accessories being used.

How to use your AGA eR7i

Getting started

When switching on the AGA cooker for the first few times, there are two things you may notice, neither of which should cause concern.

The AGA cooker will emit an odour for a short while, this is simply due to the protective oil we put on the hotplate and ovens burning off. Due to the newness in the first couple of hours, it is advisable to open the kitchen window while this takes place.







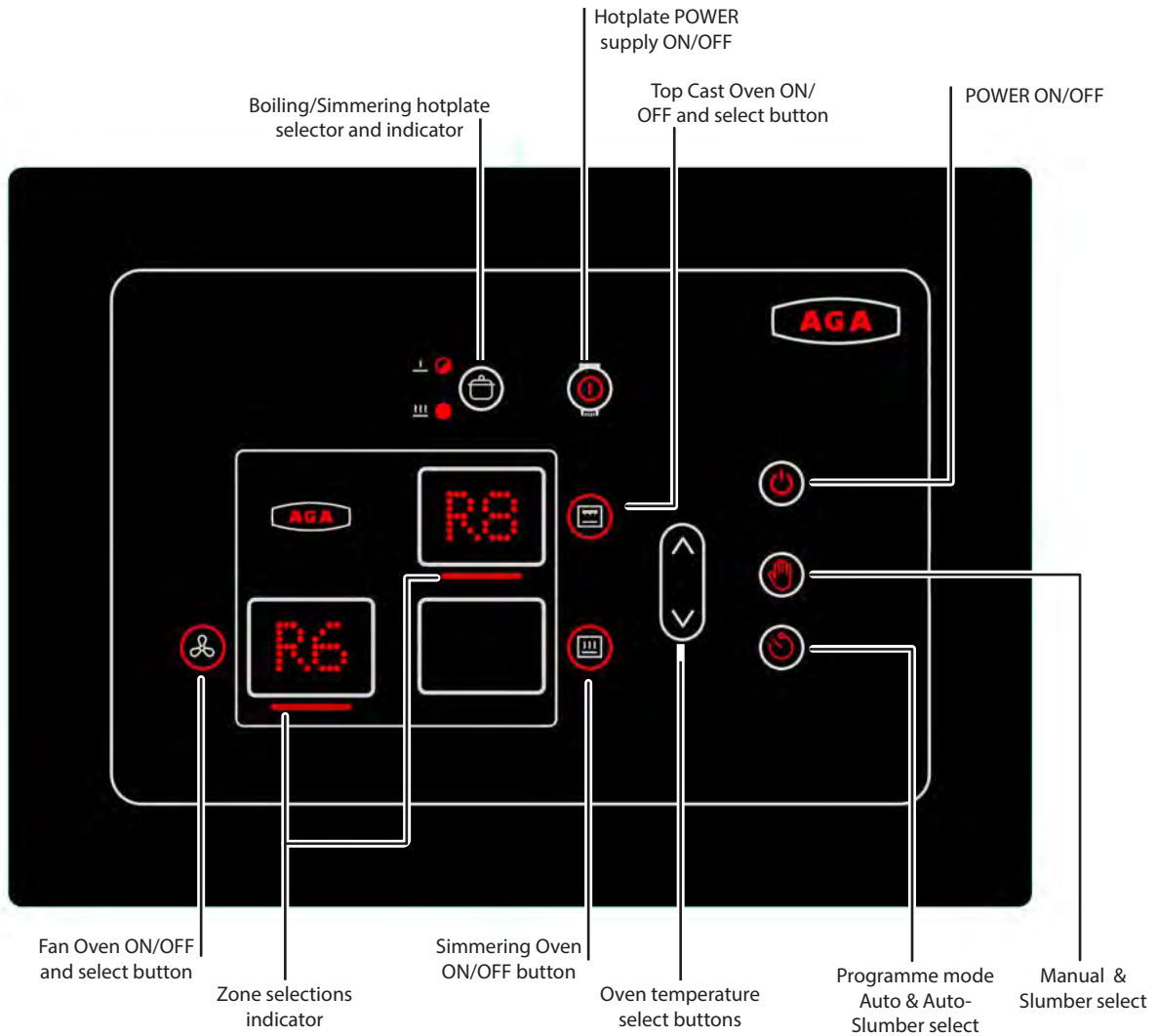





Condensation may occur on the top and front plate whilst the AGA cooker is heating up, caused by the insulation lagging and starch binder on the element insulation drying out. The condensation should be wiped away as soon as possible to prevent staining the enamel.

Your AGA eR7i has the external appearance of a classic AGA heat storage enamelled cast iron cooker. However its flexibility is almost unbounded because in place of a single heat source each cooking zone has its own electrically heated cast iron element(s). The separation of cooking zones, allows a choice of control. You are able to select only the zones that you want, or need, to use.

The control panel is situated behind the top left hand door and has a capacitive touch screen with LED indicators and character display to indicate which zone is activated and what setting is selected. An audible beep will confirm selection.



Operating Cast Iron Hotplate

Function	Symbol	Symbol(s) illuminated
Turn on the appliance		  
Turn on the cast iron hotplate		
Select setting once for simmer and twice for boiling		 <p>Outer ring will blink red until desired temperature is reached when it will go solid Select within 3 seconds of pressing the 'Hob Power' button or it will deactivate.</p>
Turn off hotplate		 <p>3 seconds after hob power will switch off</p>
Turn off all zones (ovens and hob) is via the main power on/off button		

Using the zones of the AGA eR7i

The hotplate

The hotplate is operated manually, make sure the standby button is on then just press the touch control panel for the hotplate you need, once for the simmering setting and twice for boiling setting. A flashing red light will appear, when the hotplate reaches its full pre-set heat, it will become solid red.

The boiling setting is the hottest with the simmering setting being the cooler of the two. An electric element is embedded into the cast iron which heats up in approximately 15 and 10 minutes respectively. The hotplate can be used completely independently from the ovens.

This means the AGA eR7i differs from the classic AGA heat storage cooker in that they can be used for the entire cooking time of appropriate dishes because the design keeps the hotplates at a constant heat, whereas the classic AGA cooker continues to cook on a falling heat so for these we recommend starting on the hotplate then transferring to the ovens, this can be done with the AGA eR7i but is not necessary. For instance, if making a pasta dish with sauce on the AGA eR7i, it can all be done on the hotplate.

The whole hotplate area can be used for cooking and several pans can be accommodated on the plate at any one time. **DO NOT** drag the utensils from one area to another as the enamel will suffer!

When stir frying or cooking anything that is inclined to splash, we would recommend using an AGA Splash Shield which will protect the insulated cover from splatter, making cleaning a doddle! Just wash the Splash Shield in hot soapy water or place in a dishwasher between two dinner plates.

Please be advised the boiling plate is too hot to cook food direct on it.

Only certain types of glass, glass-ceramic, earthenware or other glazed containers are suitable for hotplate cooking; others may break because of the sudden change in temperature.

The stainless steel insulated cover is brought down over the hotplate when it is not in use. When the hotplate is 'on' the insulated covers will be warm. We **strongly advise** not to put anything such as kettles, saucepans or baking tins directly onto the insulated cover because it will show any scratches – invest in a chef's pad to protect the surface if the cover is to be used as resting place!

Keep the hotplate clear of any burnt on food or crumbs by brushing with the wire brush, supplied with your AGA. Cleaning details can be found on **“Caring & cleaning” page 62.**

2 Zone Induction Hotplate

The induction hobs work independently of the AGA hotplate and ovens. The entire induction hob functions are accessed via the touch pads built into the ceramic surface of the induction hotplate.

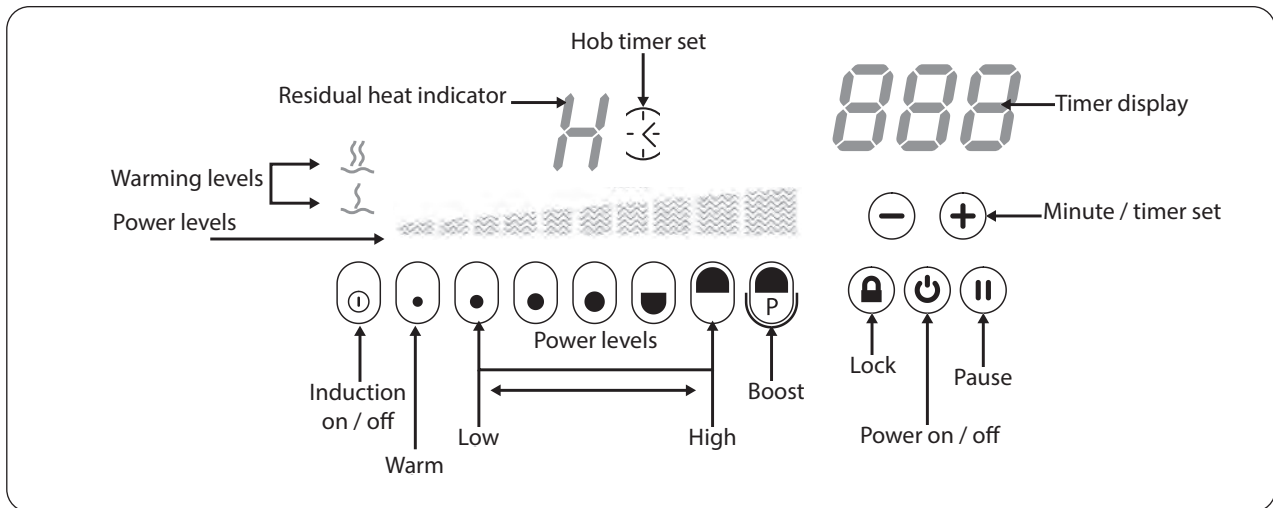

Pans

It is important to use pans that are specifically recommended for induction cooking. Generally stainless steel, special pans with stainless steel bases, enameled steel, or cast-iron pans with flat enameled bases are suitable. It should be noted that some grades of stainless-steel pans may not function or may be slow to heat. All copper and all aluminum constructed pans or ceramic pans will not work on an induction hob.

If you are unsure of a pan, try a quick test using a magnet on the pan base. A strong attraction between magnet and pan, will normally indicate a suitable pan. Weak or no attraction usually indicates a pan that is not suitable.

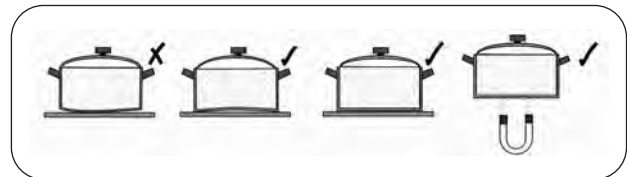

DO NOT forget to remove the magnet before using the pan on the hob.

Position the pans and centralise over the marked zone. **DO NOT** use oversize pans which overlap the controls and display area, 180 – 240 mm pans are an ideal size. Using a pan with a lid will help pan contents boil more quickly. Ideally pans should have near flat bottoms to maximise induction efficiency.

Error codes E2 and E6, displayed on your induction hob, can be associated with use of poor-quality cookware or cookware not suitable for induction. Continued use may cause serious damage to your induction hob.

Most types of pans will generate a faint audible sound during the cooking process, and this is perfectly normal. The level of sound will vary depending on the type and style of pan used. Accessories can be viewed at your local AGA specialist or online at www.agacookshop.co.uk.

Pan Detection

When the power is on and a power level is selected, the pan detection will be automatic whenever the pan is placed within or removed from the cooking zone on the hob. (See **Fig. 1.1** for defined pan area and pan location).



Display Indicators			
A	Auto Cook	~ ~ ~ U	Warming settings
U	Pan detection	⊖	Timer set
H	Residual heat		Pause set
P	Boost	▬▬▬▬▬▬	Power levels
UN	Bridging	⌋	Prolonged pad contact

Residual Heat Indicator

The hob surface will get hot when in use, this is due to heat being conducted from the cooking pan. The hob surface will also remain hot for a while after use.

After the cooking period the hob hot indicator (**Fig. 1.2**) will be displayed and for a short period of time after power off.

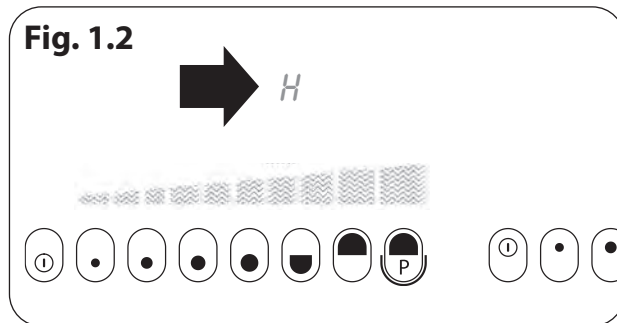

Control Panel

Always use positive finger contact on the touch pads to ensure a good control response.

Touch pads may not respond if the hob control area is wet. Touch pad area should be dried using paper towel.

Overheat Protection

Power levels will be automatically reduced if excessive high temperatures are monitored below the cooking zone. If high temperatures are detected it will not be possible to adjust the power level to a higher level than shown in the visual displays.

Should a pan be allowed to boil dry the overheat system will turn the hob off.

Power Boost

Please note power boost will last for up to 10 minutes on one zone only. When power boost is in operation on one zone it will automatically reduce the power to the second zone.

Using the Induction Hob

Step 1. To switch on touch the standby.

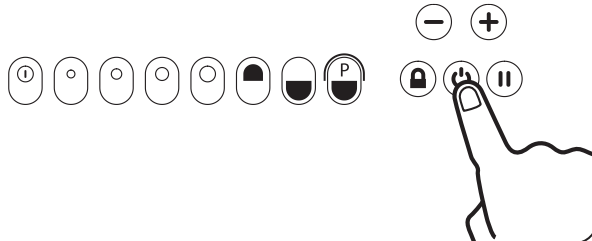

Step 4. Boost level. Power boost will last for up to 10 mins, before reverting back to setting.

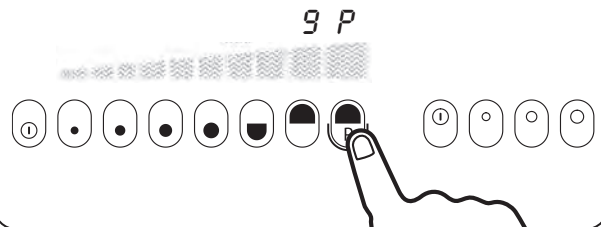

Step 2. Touch the induction on. If power level is not set within 20 seconds the unit will automatically switch off.

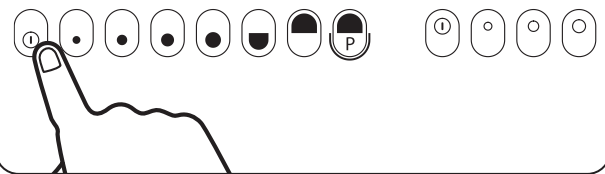

Step 5. To switch off touch the standby.

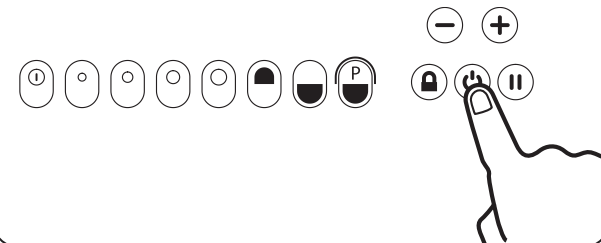

Step 3. Set the required power level.

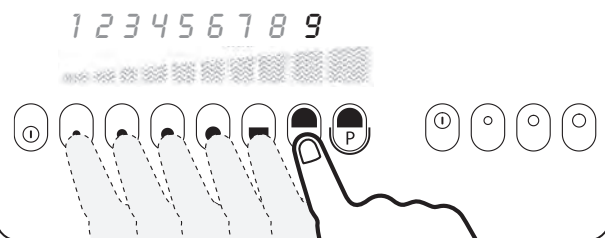

Pause

Step 1. To interrupt the cooking period, touch the pause.

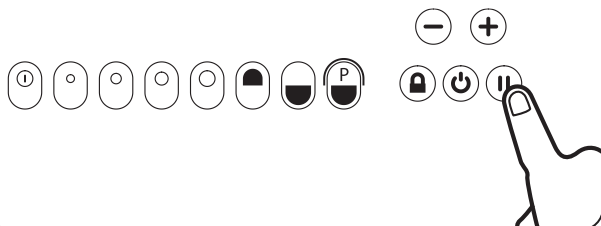

Step 2. To recommence cooking, touch the pause and then slide your finger the full length of the power level pads.

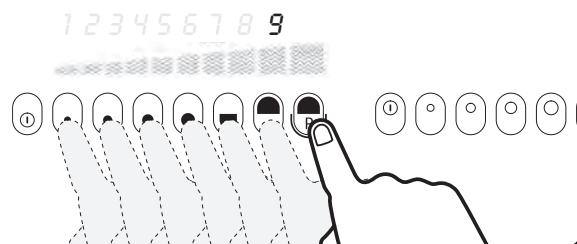

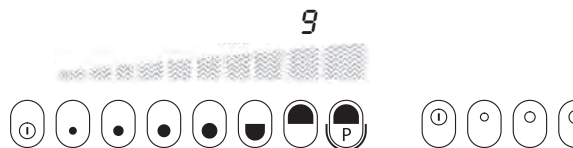

Step 3. The original power level will be automatically set.



Pause remains active for 10 minutes only.
After 10 minutes the hob will switch off.

Warming Function

The warming function will keep cooked food warm for a set period of time.

Level	Temperature	
1 	40°C 104°F	Melting
2 	70°C 158°F	Warming
3 	94° C	Simmer

Step 1. To switch on touch the standby.

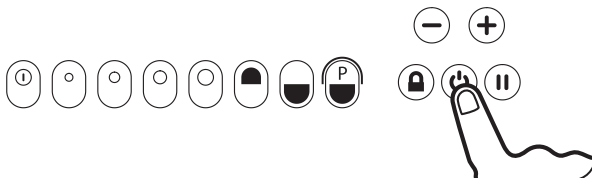

Step 2. Touch the induction on. If power level is not set within 20 seconds the unit will automatically switch off.

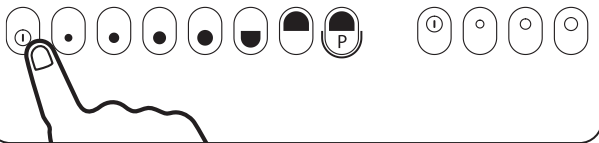

Step 3. Touch the first power level pad to select warming level one.

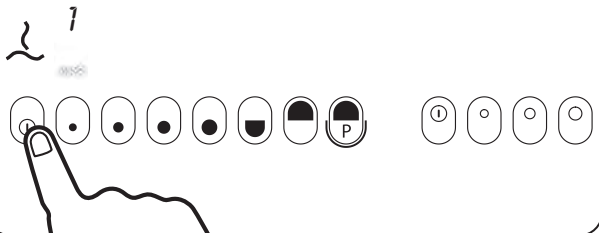

Step 4. To select the second warming level, touch and hold the first power level.

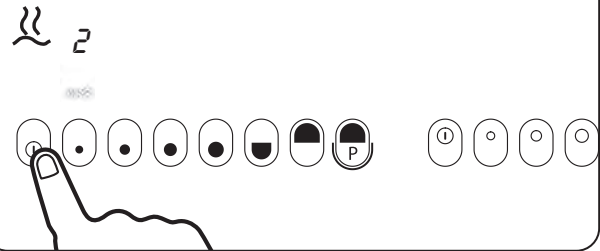

Step 5. To select the third warming level, touch and hold the first power level.

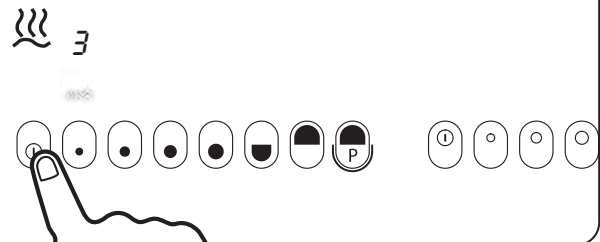

Step 6. To cancel the warming function, touch and hold the first power level.



Auto Cook

The Auto Cook feature allows the pan contents to be brought up to a high temperature rapidly, before reverting back to the set power level.

Step 1. To switch on touch the standby.

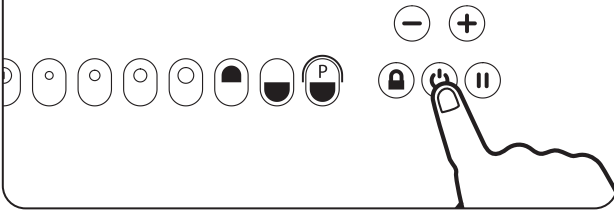

Step 2. Touch the induction on. If power level is not set within 20 seconds the unit will automatically switch off.

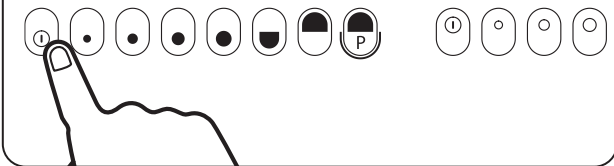

Step 3. Touch required power level pad for 5 seconds. The symbol *A* along with the power level, will flash in the display.

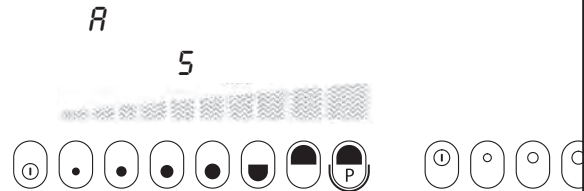

Step 4. To switch off touch the standby.



1. Timer Function

The timer functions do not start or stop a cooking process. The hob has two individual timers:

1. **Kitchen Timer**, for general kitchen timing requirements, for example, timing food cooked in an oven.
2. **Minute Minder**, for timing the duration of the induction cooking process.

Kitchen Timer

Step 1. To switch on touch the standby.

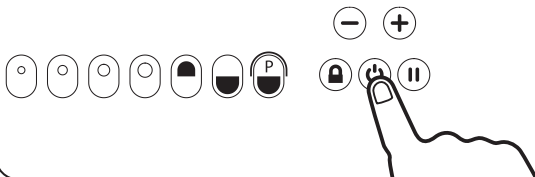

Step 3. A time can now be set using - or +. The count down will commence after a few seconds.

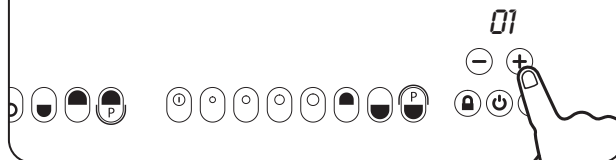

Step 2. Press the "-" and "+" button together.

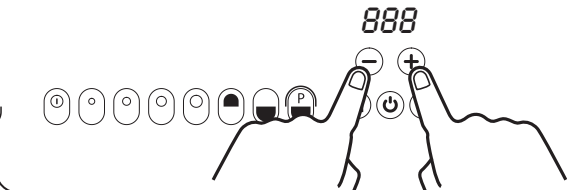

Step 4. If an instant countdown is required touch the power pad.

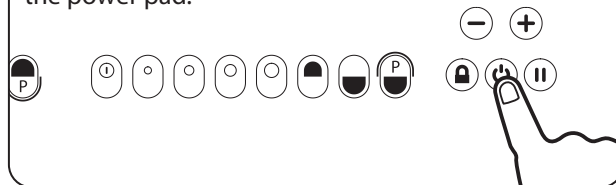

After the set time has elapsed an alarm will sound. To cancel touch the power off pad.

Modify Kitchen Timer

Step 1. To modify or cancel a previously set time, touch the standby.

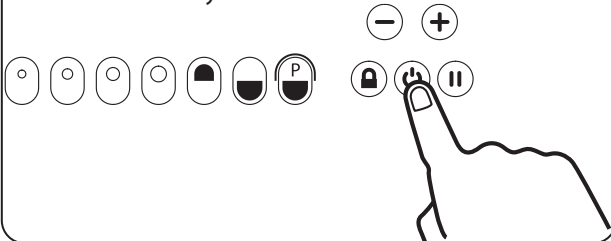

Step 2. Press the "-" and "+" button together.

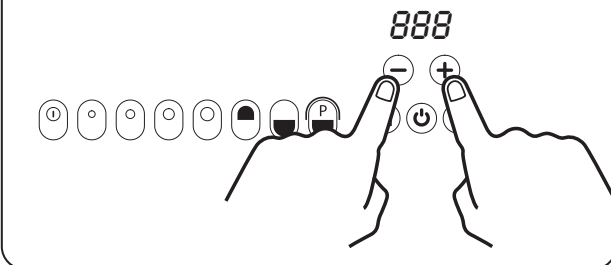

Step 3. The time can now be modified by using the + or - symbols. To cancel the kitchen time; set the time to 00 or touch the standby.

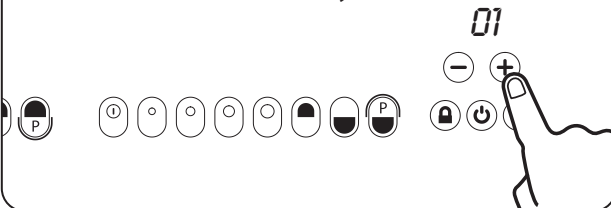

2. Minute Minder

Step 1. To switch on touch the standby.

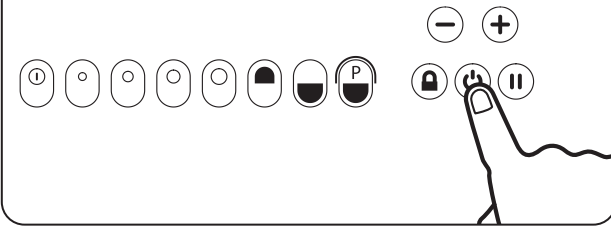

Step 2. Touch the induction on. If power level is not set within 20 seconds the unit will automatically switch off.

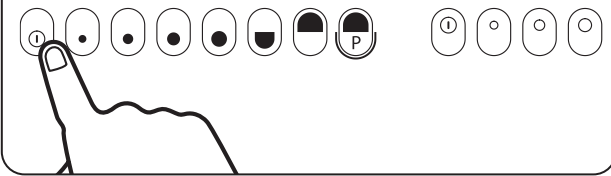

Step 3. Set the required power level.

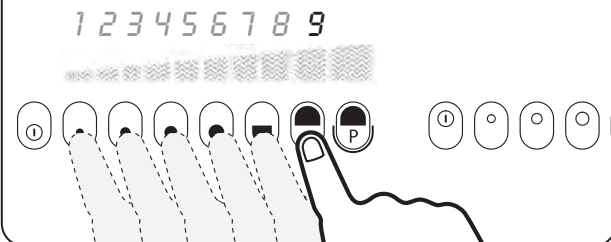

Step 4. Press the "-" and "+" button together.

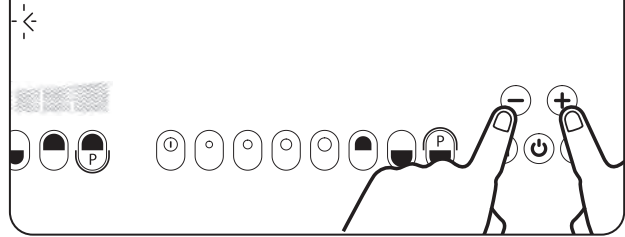

Step 5. The time can now be set by using the - or +. The count down will commence after a few seconds.

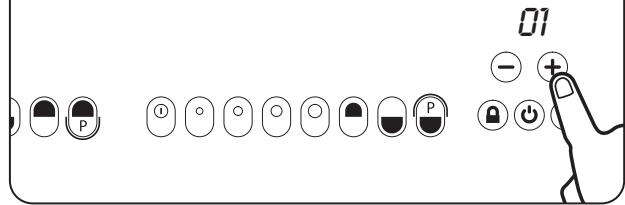

After the set time has elapsed an alarm will sound.
To cancel touch the power off pad.

Modify Minute Minder

Step 1. Press the “-” and “+” button together.

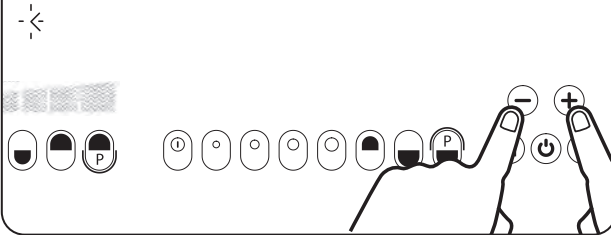

Step 2. The time can now be set by using the - or +. The count down will commence after a few seconds.

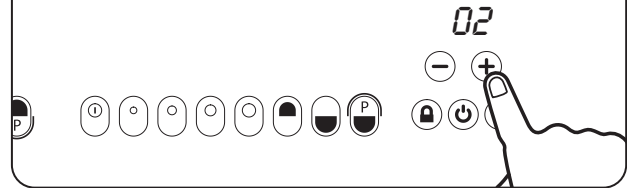

3. Temporary Lock

Temporary Lock, this feature will lock the controls for the duration of a cooking process to prevent accidental adjustment of the controls.

Step 1. Touch the power button.

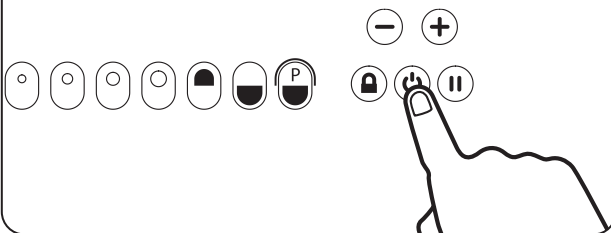

Step 2. Touch the induction on. If power level is not set within 20 seconds the unit will automatically switch off.

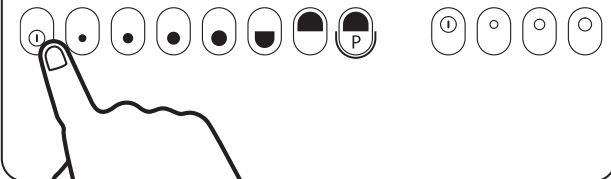

Step 3. Set the required power level.

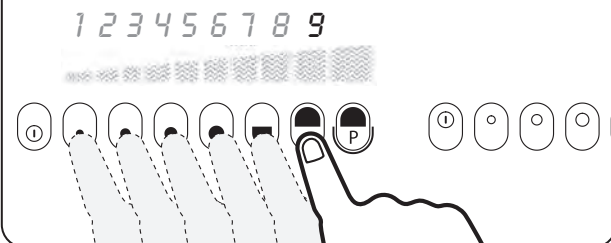

Step 4. Touch the lock to reset power level adjustment (a) or power pad to turn the hob off (b).

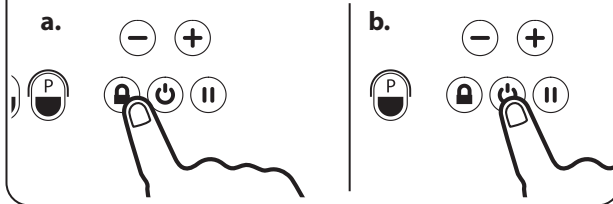

Step 5. To remove the feature, after use touch power on (a) pad and then lock pad (b).

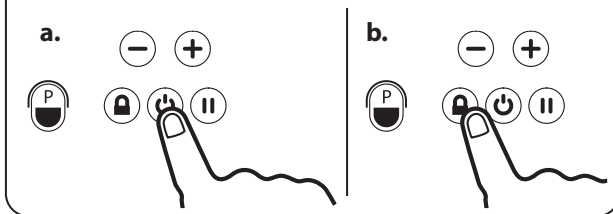

Bridge Function

The bridge function allows both cooking zones/elements to be switched on at the same time and controlled as one cooking zone only.

This is ideal for an induction compatible griddle or fish kettle for example.

Step 1. Touch the power button.

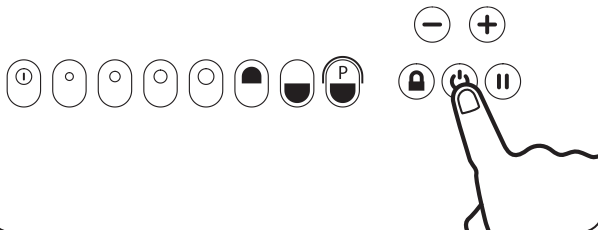

Step 3. Set the required power level by the left slider only.

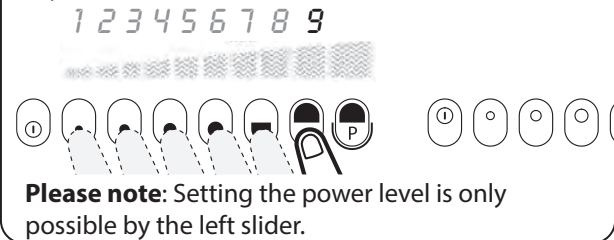

Please note: Setting the power level is only possible by the left slider.

Step 2. Activate by selecting both cooking elements simultaneously.

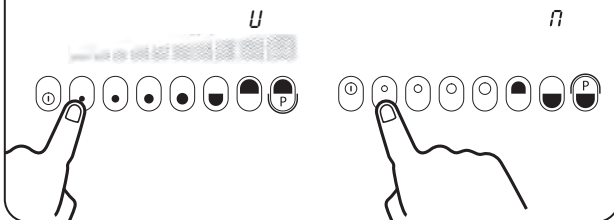

Step 4. To switch off touch the standby.

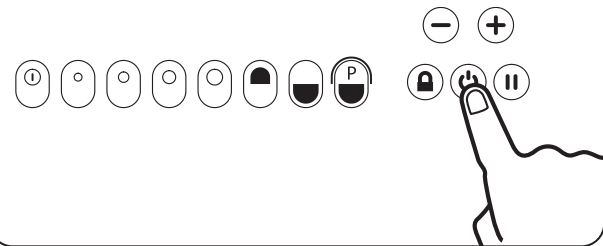

Cooking on your AGA eR7i; ovens overview

The cast Roast & Bake heat storage oven & grill



The top heat storage cast oven is indirectly heated by two elements, one in the base of the oven and the other on the roof. These elements heat the cast iron and the air within to provide cooking results consistent with the AGA heat-storage cooker, with the flexibility of being able to change the cooking temperature.

As well as cooking on 8 settings, this oven has a grill setting. **“Cooking on your AGA eR7i” page 36.** When cooking on the floor of the cast oven for long periods of time (more than 30 minutes), place the floor grid on the floor of the oven before putting the food into the oven, this lifts the food away from the base element to ensure best cooking results are achieved.

The oven is zoned in heat, meaning it is slightly hotter towards the top than the centre and the oven grid shelf set on the oven floor is slightly less hot than the centre.

The roasting settings R6-R9 are excellent for bread and pastries. Quiches in ceramic or pies in Pyrex dishes need not be baked blind as when they are placed on the floor of the oven the pastry cooks from underneath and the filling will set and brown from the all-round heat. However, metal tins conduct heat quicker than ceramic so always place them on the floor grid on the floor of the oven to avoid over browning.

The baking settings B1-B4 provide ideal temperatures for a range of baked items, from Pavlova and custards to cakes and biscuits.

The specially designed roasting tins and bakeware slide directly onto the runners, so almost every available square centimetre of space can be used.

A note when cooking on the floor of the top cast oven:

- Please leave 1 hour before cooking directly on the floor of the oven, this is to ensure maximum temperature stabilisation of the base element.
- You can cook directly on the floor of the roasting oven for short periods of time e.g. pizza, quiche.

The beauty of the oven is that any fat splashes are burnt off when the oven is at full heat, just brush out occasionally to get rid of carbon deposits. High moisture foods might create some condensation during cooking. Wipe up any moisture gathering on the enamel as soon as possible.

Grill

The grill is suitable for all types of grilling and browning foods.

Preheat and grill with oven door closed to retain heat. The grill works best preheated for 2 minutes from R settings or 5 minutes from slumber, but can be used if preheated for 10 minutes from cold.

Open the door slightly before opening fully to allow steam to escape especially if using from R settings

Use for up to a maximum of 45 minutes for best results.

For safety the grill cycles, so don't worry if it doesn't look as red and glowing, it is still cooking. The grill will automatically cut off at 60 minutes to avoid accidentally leaving it on.

Slumber mode

The simmering oven is always in Slumber, whereas the top cast oven can be set on Slumber mode for either cooking at a low heat, or to generate gentle warmth into the kitchen, or in readiness for turning up to a pre-set heat when required. The light will flash when heating up to slumber, then go solid when up to temperature.

Cooking in Top cast oven on slumber

When this oven is set at Slumber it operates like a simmering oven can be used to cook rich fruit cakes or slow cook roasts, casseroles and curries. With the exception of meringues and rich fruit cakes, food that is to be slow cooked should be brought up to heat before placing in an oven at Slumber.

The cast Simmering heat storage oven



The simmering oven can be described as a continuation oven, it continues to cook food that has been brought up to heat elsewhere on the cooker with the exception of meringues which are dried out rather than 'cooked'.

The specially designed roasting tins and bakeware slide directly onto the runners, so almost every available square centimetre of space can be used.

The simmering oven is indirectly heated by one element in the base of the oven.

This element heats the air and the cast iron within to provide cooking results consistent with the traditional simmering oven of an AGA heat-storage cooker, with the flexibility of being able to turn it to Off when not required. When selected the simmering oven is always at a simmer or Slumber mode ideal for long slow cooking.

The floor grid is used here to protect items placed on the floor of the oven such as vegetables for steaming, keeping sauces warm or casseroles cooked for a long time. Always ensure this is in place, before putting food into the oven.

All food (except meringues), should be covered to avoid excess moisture and condensation forming.

The cast Simmering heat storage oven - User Guidance

- Allow the oven to heat up fully, the longer the oven is on the better, since this helps reduce the amount of moisture created during simmering.
- To get the very best performance, we recommend to use AGA cookware with thick bases and stacking lids.
- **DO NOT** place dishes directly on to the oven base. Always place onto either a shelf or the floor grid.
- Joints of meat and poultry should be brought up to heat on a roasting setting for 30 - 45 minutes, before transferring to the simmering oven. This method is unsuitable for stuffed meat and poultry.
- Make sure that pork and poultry reach an internal temperature of at least 75°C.
- Always bring soups, casseroles and liquids to the boil before putting in the simmering oven.
- Always thaw frozen food completely before cooking.
- Root vegetables will cook better if cut into small pieces.
- Adjust seasonings and thickenings at the end of the cooking time.
- Many dried pulses and beans for example, dried red kidney beans must be boiled for a minimum of 10 minutes, after soaking, and before inclusion in any dish.

PLEASE NOTE: DO NOT store anything in the simmering oven and **DO NOT** use large cookware such as the large baking tray and large meat tin until the oven has reached it's operating temperature. Failure to do this may cause the safety function to lock in the OFF position. It is also advisable when using large cookware in the simmering oven to push it to the back of the oven.

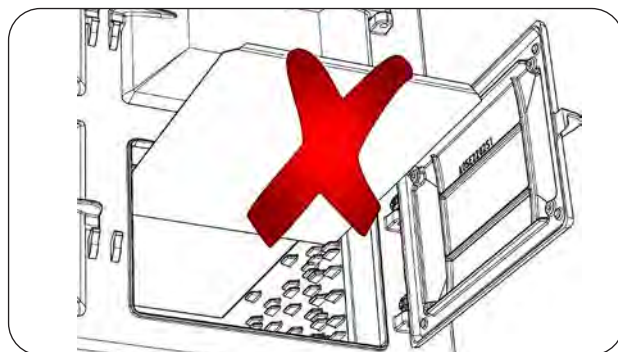

Oven venting

The AGA eR7i ovens are vented through outlets located centrally to the rear of the top plate. The venting system is designed to vent the moisture from the oven and must NOT be covered.

It is recommended to install a cooker hood above the AGA eR7i. The cooker hood should be positioned not less than the minimum height as recommended by the manufacturer from the top of the AGA.

The venting of the oven also means that you can cook sweet and savoury items together without danger of mixing flavours - a delicate lemon sponge can be cooked in the same oven as garlic mushrooms!

To ensure simmering oven is effectively vented, always place food on a shelf or floor grid on the floor, **NEVER** directly on the floor as this can cause excessive steam and condensation.

The Fan oven



The fan oven is heated by an element in the back of the oven and hot air is distributed around the cavity by a fan. This allows for a faster heat up time and the flexibility of a range of cooking temperatures; B1-B4 for baking and R6-R9 for roasting.

See **“Cooking on your AGA eR7i” page 36**

Cooking Tips

Place dishes, tins and tray on the shelves and ensure there is space around the trays to allow air circulation.

For even browning turn trays part way through cooking.

If cooking several trays, you may need to swap the trays on the shelves part way through the cooking to ensure best results. The large enameled roasting tin is not suitable for use in this oven.

The oven is efficient so you might need to reduce cooking times or temperatures. High moisture foods might create some condensation during cooking.

Wipe up any moisture gathering on the enamel as soon as possible.

Cooking on your AGA eR7i

General advice

Food **SHOULD NOT** be placed into any oven until it is up to normal operating heat i.e. the red light of the selected oven is solid and not flashing.

The oven doors should not be left open for long periods of time during cooking and heating up.

Warm up times

When a zone is heating up it will be indicated by a blinking red light on the control panel. When a zone has reached temperature a solid red light will indicate it has warmed up. AGA recommends that to fully saturate the castings it is best to leave them for one hour for the optimum cooking results.

Cooking zone	Approximate heat up time
Boiling setting	15 minutes
Simmering setting	10 minutes
Grill	10 minutes from cold 2 minutes from R6
Cast Ovens	Approx 1 hour
Fan Oven	Within 12 minutes (R9)

PLEASE NOTE: The times are based on each zone being operated individually. If a large combination of zones are turned on simultaneously, it may slow down the individual warm up times. If all zones are turned on at the same time it will take approximately one hour for the whole appliance to reach operating temperature.

AGA eR7i ovens settings

The Aga eR7i is designed to give you flexibility when cooking a range of dishes using top cast oven, grill, fan assisted oven and long slow cooking in the simmering oven. When referencing recipes from cookbooks, **the eR7i pre-set cook settings are equivalent to the gas mark number**. This guide gives an indication of the settings for specific foods, but the degree of cooking is often down to personal taste and you will soon find the settings which suit you. Happy cooking!

eR7i Pre-set oven settings	Description	Equivalent cooking Temperature °C	Equivalent Fan Oven Temperature °C	Typical Food Type
Simmering / Slumber	Very low	110 - 120	90 - 100	Very slow drying of meringues Slow cooking of stews, casseroles, meats, vegetables and poaching fruit. Food must be brought to temperature before placing in the simmering oven with the exception of meringues.
B1	Cool	140	120	Slow braised meat eg salt beef. Very rich fruit cake, pavlova.
B2	Slow	150	130	Slow roast eg. pork belly, ribs, gammon, lamb. Simnel cake, finishing lemon meringue, rice pudding, shortbread, cherry cake, custards eg crème caramel
B3	Moderately low	160	140	Curry, casseroles, stews, gammon, slow cooked meat, suet puddings eg steak and kidney, chilli. Cherry cake, Madeira cake, light fruit cake and cheesecake.







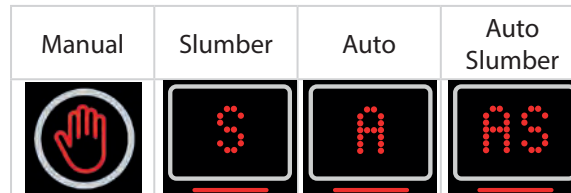



eR7i Pre-set oven settings	Description	Equivalent cooking Temperature °C	Equivalent Fan Oven Temperature °C	Typical Food Type
B4	Moderate	180	160	Tray bakes, sandwich cakes, small cakes, flapjacks, biscuits, bread and butter pudding, roulade
R6	Hot	200	180	Pastry, pizza, garlic bread, gratin, baked fish, baked chicken, toad in the hole, roasting meat, browning potato toppings on pies, moussaka, lasagne, baked vegetables eg dauphinoise potatoes, roasting nuts, finishing pasta bakes and souffle. Fairy cakes, swiss roll, muffins, crumble.
R7	Hot	220	200	Bread, choux, roasting meat, soufflé, fish cakes, crackling, puff pastry pies and tarts, roasted vegetables and potatoes, baked potatoes, browning potato toppings on pies. Blind baking pastry, fruit pies, scones, quiche.
R8	Very hot	230	210	Roasted Mediterranean vegetables, potatoes. Fast roasting meat and poultry. Pizza and grilling
R9	Very hot	240	220	Fast grilling
G Top cast	Very hot			Position 2: thinner foods e.g. toast, bacon Position 3: thicker foods e.g. burgers, fish Position 4: browning dishes e.g. cottage pie

Operating the AGA eR7i ovens

Manual mode *(cast and fan ovens only)*















Function	Touch Symbol	Symbol(s) illuminated
Turn on the appliance		
Select an oven	 Touch the desired symbol to activate	The selected oven symbol will blink until the desired temperature is reached. Top/Grill: Fan: Simmer: The simmer oven is fixed temperature and does not have a display window
Changing the oven setting (Top/Grill & Fan)	 or 	A RED line will appear under the oven display window. The setting can only be changed while the RED selection bar is illuminated. Use the arrow buttons to change between B1 – R9 (and 'G' for grill on top oven only). The RED selection bar will remain active for 30 seconds.
Switch off Top/Grill & Fan oven		To switch off an oven, touch the required symbol twice, once to select and once to de-activate.
Switch off Simmering oven		Touch symbol once.
Switch off all zones (ovens & hob)		





Function	Symbol	Symbol(s) Illuminated	
Select setting fan oven	<p>Fan</p> 	 <p>Red line will appear under the oven symbol.</p>	 <p>Use button to change setting.</p>
Turn off single cast oven - select oven and touch again to switch off		<p>Top/Grill</p> 	<p>Simmer</p> 
Turn off fan oven	<p>Fan</p> 		
Turn off all zones (ovens and hob)			

Slumber mode *(cast ovens only)*

In this mode, both cast ovens are active















- top cast oven is pre-set to approximately 120°C.
- simmering oven is pre-set to approximately 100°C.







Function	Symbol	Symbol(s) illuminated
Turn on the appliance		  
Select slumber	 Touch and hold for 3 seconds	  <p>The manual symbol will blink and the letter 'S' is illuminated in the top oven display window to indicate that the cooker is in slumber mode.</p>
		<p>The selected oven symbol will blink until the desired slumber temperature is reached.</p> <p>Top/grill  Simmer </p>
Override slumber via top cast oven.	  	 <p>A RED line will appear under the oven display window. The setting can only be changed while the RED selection bar is illuminated. Use the arrow buttons to change between B1 – R9 (and 'G' for grill on top oven only). The RED selection bar will remain active for 30 seconds. The cooker will now be in manual mode.</p>

Function	Symbol	Symbol(s) illuminated
Cancel slumber mode	 <p>Touch and hold for 3 seconds</p>	 <p>The manual symbols stops blinking and the cast ovens are switched off.</p>
Turn off all zones (ovens and hob)		

Auto mode *(cast ovens only)*

















This mode setting brings selected cast iron ovens up to full heat from off. The ovens can be selected to operate once or twice each day. Each operation is termed an 'event', the start and finish time is chosen by you unless you use the pre-set time.







Function	Symbol	Symbol(s) illuminated
Turn on the appliance		  
Select AUTO		   The letter 'A' illuminates in the Top oven display window and the simmering oven symbol will blink to indicate these ovens are selected in auto mode. (N.B the simmering oven symbol continues to blink until an event period as started and the temperature reached).
Select Top oven setting	  	 A RED line will appear under the oven display window. The setting can only be selected while the RED selection bar is illuminated. Use the arrow buttons to change between B1 – R9 ('G' / grill is not selectable in auto). The RED selection bar will remain active for 30 seconds.
De-select the top oven		 To de-select the top oven, touch the symbol twice, once to select and once to de-activate.

Function	Symbol	Symbol(s) illuminated
De-select the Simmering oven		 Touch symbol once.
Cancel AUTO		  Touch the manual symbol to return to manual mode
Turn off all zones (ovens and hob)		

Auto Slumber *(cast ovens only)*

This mode setting brings selected ovens up to full heat from Slumber. The ovens can be selected to operate once or twice each day. Each operation is termed an 'event', the start and finish time is chosen by you unless you use the pre-set time.

Function	Symbol	Symbol(s) illuminated
Turn on the appliance		  
Select AUTO SLUMBER	 Touch and hold for 3 seconds	    The AUTO symbol will blink to indicate the cooker is in auto slumber mode. The letter 'AS' illuminates in the Top oven display window. The top oven symbol and the simmering oven symbol will blink to indicate these ovens are active, they continue to blink until slumber temperature is reached.
Select Top oven setting	  	 A RED line will appear under the oven display window. The setting can only be selected while the RED selection bar is illuminated. Use the arrow buttons to change between B1 – R9 ('G' / grill is not selectable in auto). The RED selection bar will remain active for 30 seconds.
De-select the top oven		 To de-select the top oven, touch the symbol twice, once to select and once to de-activate.
De-select the Simmering oven		 Touch symbol once.

Function	Symbol	Symbol(s) illuminated
Return to Auto from Auto slumber	 <p data-bbox="612 587 847 643">Touch and hold for 3 seconds</p>	 <p data-bbox="975 528 1409 619">Touch and hold the AUTO symbol for 3 seconds. The symbol will stop blinking and return to auto mode.</p>
Cancel AUTO SLUMBER		  <p data-bbox="1066 683 1390 743">Touch the manual symbol to return to manual mode</p>
Turn off all zones (ovens and hob)		

NOTE:

During Auto-Slumber mode the simmering oven is not affected by event periods and can be switched ON or OFF at any time.

PLEASE NOTE:

- Don't forget to include time for warm-up.
- Don't forget if you have set the AUTO/Slumber programme and have selected the AUTO/Slumber mode, an oven or ovens must be selected.
- All the selected ovens will remain at 'Slumber' between 'events'.
- The last 'AUTO/Slumber' oven selection is remembered and re-called when 'AUTO' is next selected.

AUTO and AUTO/Slumber

- The hotplate and fan oven can only be operated manually.
- Changing between any of the four operating modes, will cause the hotplates to switch OFF if in use - this is a built- in safety factor. They can be switched back on after the mode change if required.
- To activate auto you must programme the separate handset to your desired time. ("**The date/time setting screen" on page 52**)

Handset - A hand held control

for auto control of heat storage cast ovens only.

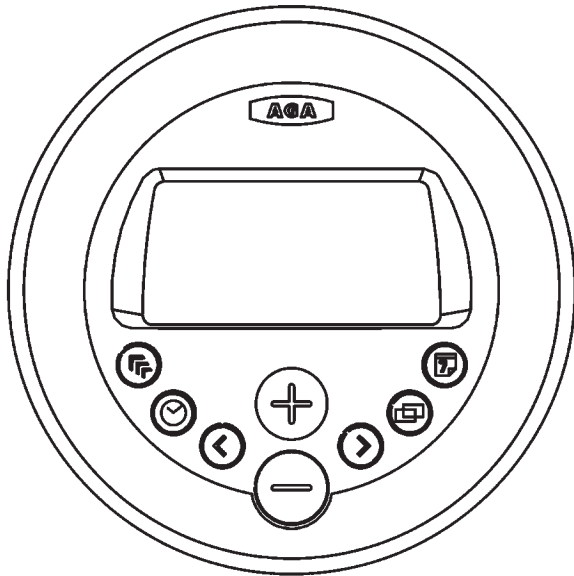

The handset displays the time, date and events. Programming uses eight push buttons. The information is displayed using a back-lit LCD screen.

Screens

The handset has 3 main screens.

The display will revert to 'sleep' mode after approximately 3 minutes. Simply press the required button to open up any screen.

1. Information Home screen (main menu)
2. Date/Time screen
3. Events Programming screen

Button operations

1. **Communication or 'Handshake' button** used initially to synchronise the handset to the AGA eR7i.
2. **Clock button** Opens and closes the date and time settings screen.
3. **Left/Back Button** Moves back and highlights the previous setting.
4. **Plus Button** Increases the highlighted setting.
5. **Minus Button** Decreases the highlighted setting.
6. **Right/Forward Button** Moves forward and highlights the next setting.
7. **Copy Button** Copies the time programme from the current day to the following day in the 7-day event calendar screen.
8. **7-day event Button** Opens and closes the 7-day event calendar screen.

Handset advice

Operating distance

The handset will only operate in the same room as the cooker and up to a maximum distance of 4 metres from the appliance. If out of recommended operating range, the handset may show 'Standby'. If this happens move the handset back to within the recommended distance and it should correct itself, see below.

Handset to AGA eR7i Signal Check

The  (Standby) symbol is shown when in the following situations;

1. Standby mode
2. Communications fail
3. A power cut
4. Handset is out of range of the AGA eR7i cooker

When transferring information from or to the controller always operate the handset in front of the cooker, this gives the strongest signal.





If the handset shows  Standby, when the cooker is on, press the  button firmly for 1 second, this will activate the communication link between the cooker and handset.

Communication/Handshake

For details on initial Communication/Handshake, see **"Communication/handshake (pairing)" page 50.**

Preview Mode

If the handset is out of range of the cooker or if the appliance is switched off, preview only mode is available. Changes cannot be made to the programmed events. The  symbol is displayed in the screen and the message 'Preview only' is displayed briefly when the events programme screen is first entered.

When in Preview Mode you can review the days by using the  and  buttons. The  and  buttons become inactive and you cannot make any changes.

Handset Failure

In the unlikely event of handset failure, the appliance would still be operational with the last selected programme. The cooker can also be changed to Manual mode from one of the auto modes using the mode button on the control panel. If the handset is damaged or lost, a replacement can be obtained from AGA and re-programmed to suit your appliance.

DO NOT PLACE THE HANDSET ON ANY HOT SURFACES.

Communication/handshake *(pairing)*

This process will be required on the original installation of the AGA eR7i. If the handset is replaced for any reason the new handset will need to be synchronised.

- You will also need to set the time and date.
- You will also be given the option to set your own Auto programme preferences.

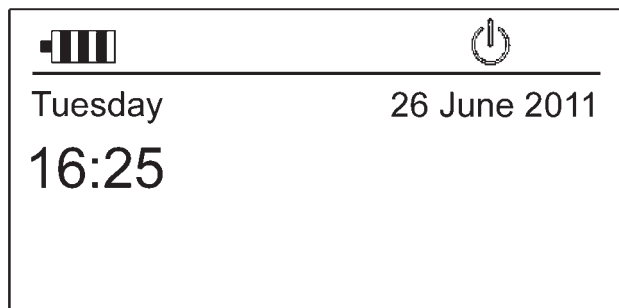

Step 1



Handshake can be activated 30 seconds after mains power has been applied to the cooker. The Standby button on the touch panel must be 'ON'. It must then be completed within 2 minutes, otherwise you will need to repeat the process.

Step 2

Press and hold  button on the handset for 10 seconds to open the communicate/synchronise screen. The following screen message then appears.

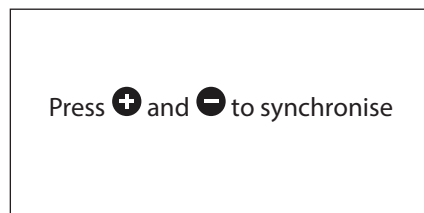
Step 3



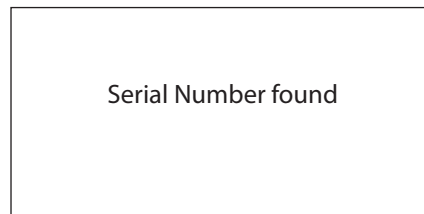

Simultaneously press the  and  buttons, the serial number will be 'found' by the handset.

The following screen message then appears briefly.



Step 4

Use the  and  buttons to choose the language you want the handset text to be in, then press  to confirm the language choice required.

Once time and date has been set the Auto/Event programme screen will appear.



Step 5

Set the correct time and date see **“The date/time setting screen” page 52.**

Step 6

You have the option to set your own Auto programme at this stage, see **“The date/time setting screen” page 52.** If you wish to leave until later, then press  it will remain at the pre-set times: 1 Event 7am - 7pm (7 days).

Notes

-  Symbol appears in the top right hand corner of the screen, if the handset is out of range with the cooker or the communication/handshake process has not been completed. When communication is OK then  symbol is displayed.
- The  button can be used to force communication between the cooker and the handset. This function is active once successful initial communication has been made, and the handset is in range.

The date/time setting screen

Press and hold Clock button  until the screen is displayed.

In this screen the time, date, month and year can be altered/set.

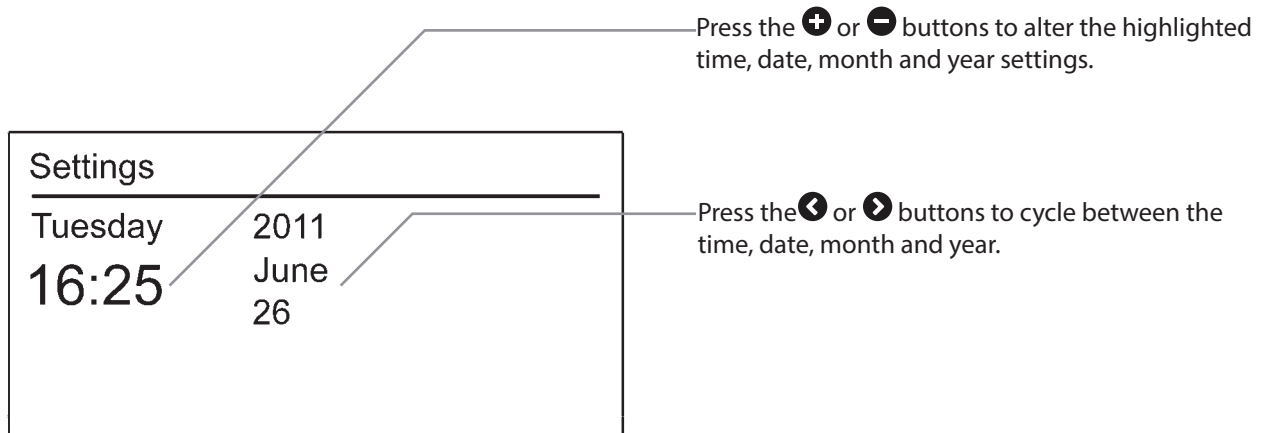

Press  button at any stage to save the settings and exit the DATE/TIME screen.

'Message sent OK' will appear on the screen when the handset is in range of the cooker.

'Changes stored on handset only' will appear on the screen, when the controller handset is out of range of the cooker.

Notes

- Even if no changes are made to the time, date, month and year settings, a press of the clock button  is still required, to return to the Home screen.
- The day cannot be changed as the handset automatically knows this information, when the date and year is set.
- The Home screen will automatically appear after the replacement of new batteries.

Auto/events programme screen

This screen is opened by pressing the 7-day event button .

In this screen, the number of events and the start and end time of events can be set. Each day can have a different number of events, and start and end times, or all seven days can be the same.

There are pre-set times already programmed, to change to your desired settings follow these instructions. Pre-set times are 1 event 7am - 7pm (7 days).

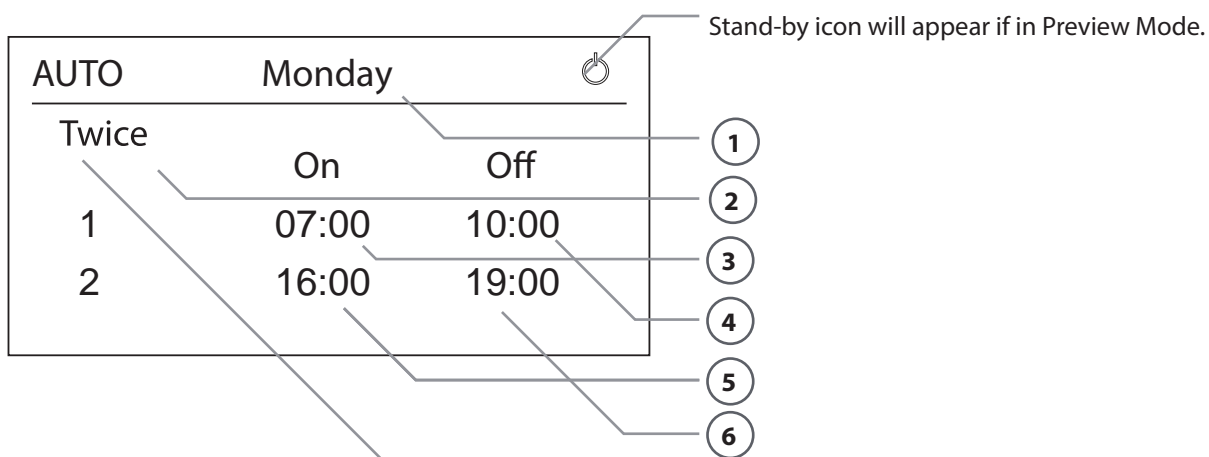

Stand-by icon will appear if in Preview Mode.

'Twice' will be shown if two events are set.

'Once' will be shown if one event is set.

'No' will be shown if no events are set.

What you can do

1. The current day is shown on the display, this can be changed to the day that you wish to edit by pressing the **+** and **-** buttons.
2. This shows the number of events in that day. This can be changed from no, once or twice by pressing the **+** and **-** buttons.
3. This shows the start time of the first event. This can be changed by pressing the **+** and **-** buttons.
4. This shows the end time of the first event. This can be changed by pressing the **+** and **-** buttons.
5. This shows the start time of the second event. This can be changed by pressing the **+** and **-** buttons.
6. This shows the end time of the second event. This can be changed by pressing the **+** and **-** buttons.

How you do it

Press the **◀** or **▶** buttons to navigate through the settings on the screen. When a setting is selected it will be highlighted by a dark box. Pressing the **+** and **-** buttons. will change the information in this highlighted box.

Press **⏪** to copy programme settings to next day.

If you have made changes and wish to exit this screen, press the **⏹** button. A 'Save Changes' - Yes or No? message will appear on the screen.

Pressing the **◀** and **▶** buttons will highlight Yes or No. Press the **⏹** button again to confirm your choice.

REMEMBER: After setting the Auto event that an oven selection must be chosen on the touch panel **🔥** if you wish to activate the programme you have just entered.

Notes

- Even if no changes are made a press of the **⏹** button is still required, to return to the Home screen.



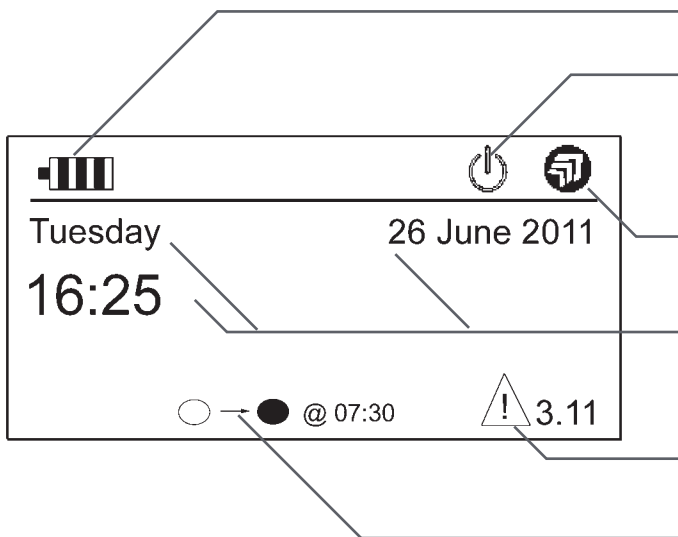

Information (home) screen

This is the main screen, where information such as time, date, battery life and connectivity is displayed. If you have programmed either of the 'AUTO' modes and they are currently in progress, the next change of event will also be displayed. The information below explains this in more detail.

Press any button on the handset to open this screen, from 'Sleep' mode.



Change of event symbols

-  **AUTO event on**
(before AUTO event)
-  **AUTO event OFF**
(during AUTO event)
-  **AUTO/Slumber event ON**
(before AUTO/Slumber event)
-  **AUTO/Slumber event OFF**
(during AUTO/Slumber event)

Symbol indicating the battery life.

If there is no communication between the AGA eR7i and the handset because: the cooker is not powered, in standby or the handset is out of range from the cooker. The  symbol is displayed.

Communication/Handshake symbol indicates communication between the cooker and handset is OK.

Symbols indicating the current time and day.

Warning triangle and error code is displayed if an error occurs.

If either AUTO or AUTO/Slumber mode is active the next event change will be displayed for that day with the relevant symbols to show start and end times.

NOTE: If standby icon is shown then event indicator will not be displayed.

Power cuts under 10 minutes

When the power is restored, the AGA eR7i will resume normal operation as was set prior to the power interruption.

Power cuts over 10 minutes

Most functions will have turned OFF.

- 'Manual' mode - all zones OFF.
- 'Slumber' mode - hotplates OFF, Slumber ON
- 'AUTO' mode - hotplates OFF, ovens continue with the set programme.
- 'AUTO/Slumber' - hotplates OFF, ovens continue with the set programme.

A 'Power Cut' message may appear on the handset screen, confirm by pressing any button on the handset. Therefore the cooker may not be at temperature when expected.

Automatic update of time

In the event of power cuts the handset will automatically update the controls within the cooker to the correct time on restoration of power. This is provided that the following criteria are met:

1. The handset is sited within range of the cooker
2. The handset has good batteries
3. The handset contains the correct time itself

PLEASE NOTE: The handset time will need to be updated with Spring and Autumn time changes B.S.T / G.M.T. See **"The date/time setting screen" page 52.**

Batteries

The handset is fitted with four 'AAA' batteries, which are packed separately. Your Engineer will insert them when your AGA eR7i cooker is installed. When replacing the batteries, follow these instructions in conjunction with the diagrams.

Remove the handset from its backplate, then remove the battery cover plate from the rear of the handset (**Fig. 1.3**).

Carefully lever out the batteries commencing with the bottom one first pushing and pulling out on the **positive (+) end only** (**Fig. 1.4**). Repeat this procedure to remove the other batteries.

Always use long life batteries for replacements - rechargeable batteries are not recommended.

Replace the batteries commencing with the bottom one working to the top (**Fig. 1.5**).

Battery life will depend on usage. Replace the batteries when the battery symbol on the handset is down to one bar.

Care and cleaning

The handset should be wiped clean using a soft clean cloth. **DO NOT** use abrasive cleaning products or submerge the handset in water.

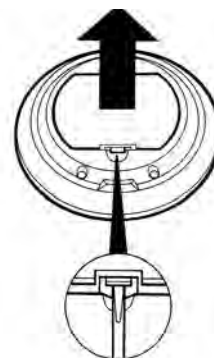

Fig. 1.3

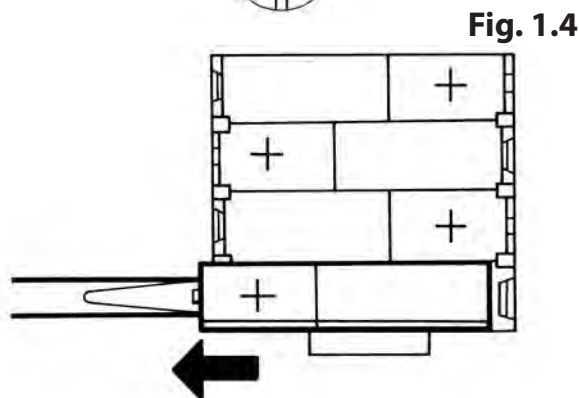

Fig. 1.4

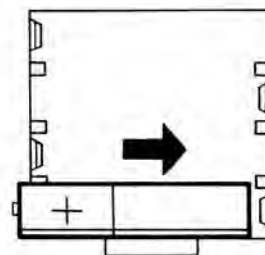

Fig. 1.5

Induction care

Important information for pacemaker and implanted insulin pump users. The functions of this hob comply with the applicable European standards on electromagnetic interference. If you are fitted with a pacemaker or implanted insulin pump and are concerned please consult your doctor for medical advice.

When the hob is in use keep magnetic items away, such as credit and debit cards, floppy disk, calculators, etc.

When the hob is in use keep metallic items away, such as knives, forks, spoons, and lids should not be placed on the hob surface since they can get hot.

To fully utilise the power of your induction hob and to ensure longevity of performance, we recommend the use of AGA Rangemaster Induction cookware. If you decide to purchase an alternative set of cookware for use on your induction cooker, we would strongly recommend that composite aluminium cookware with steel inserts, example shown **Fig. 1.6**, are avoided. This type of construction can significantly reduce the lifetime and performance of your induction cook top.

Take care when touching the marked cooking areas of the hob.

Use adequately sized pans with flat bottoms that are large enough to cover the surface of the hotplate heating area. The use of undersized pans will expose a portion of the surface unit to direct contact and may result in the ignition of clothing.

Only certain types of stainless steel, enamelled steel or cast iron cookware with enamelled bases are suitable for induction hob cooking.

Take care **NOT** to scratch the surface when placing cookware on the glass panel.

Only certain types of glass, glass-ceramic, earthenware or other glazed containers are suitable for use on the warming zone; others may break because of the sudden change in temperature.

NEVER cook directly on the hob surface (**Fig. 1.7**).

DO NOT leave the hob zones switched on unless being used for cooking.

DO NOT stand or rest heavy objects on the hob. Although the ceramic surface is very strong, a sharp blow or sharp falling object (e.g. a salt cellar) might cause the surface to crack or break (**Fig. 1.8**).

WARNING: Should a crack appear in the surface, disconnect the appliance immediately from the supply and arrange for its repair.

Always **LIFT** cookware off the hob. Sliding the griddle plate or pans may cause marks and scratches (**Fig. 1.9**).

Take care **NOT TO PLACE HOT LIDS** onto the hob surface (**Fig. 1.10**). Lids that have been used to cover a hot pan can “stick” or create a “vacuum” effect to the induction hob. Should this occur, **DO NOT** attempt to lift the lid off the glass surface, this may damage the glass. Instead slide the lid to the edge of the hob surface and remove, taking care not to scratch the hob surface. Alternatively wait until the lid has cooled to room temperature, the vacuum has been released, then remove the lid by lifting it from the hob surface.

Fig. 1.6

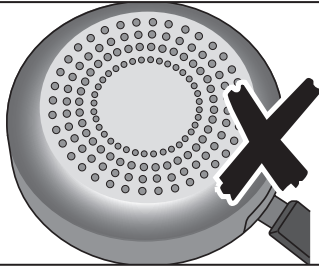

When the power is on each zone will not activate until a pan has been placed onto the zone. Then that zone will illuminate, and a power level can be selected, the pan detection will be automatic whenever the pan is placed within or removed from the cooking zone on the hob. (See **Fig. 1.11** for defined pan area and pan location)

Fig. 1.7

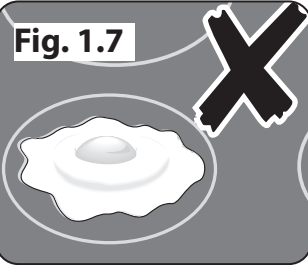

Fig. 1.8

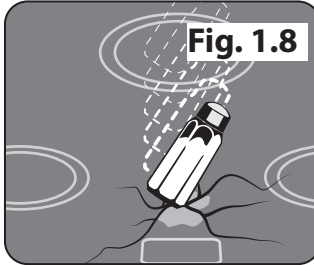

Fig. 1.11

To activate a zone the pan (dashed circle) must cover one of the two zones (the two zones are indicated by the two circles).

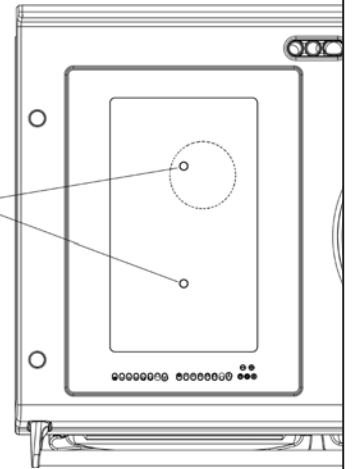

Fig. 1.9

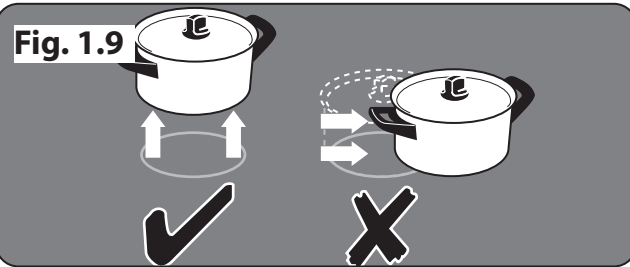
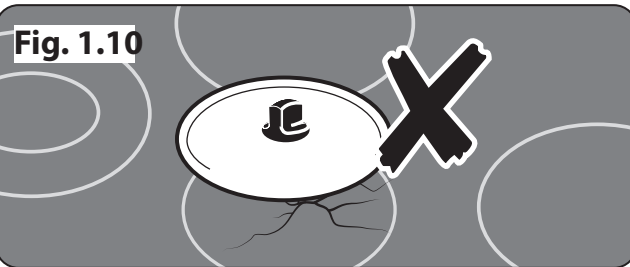

Fig. 1.10



AGA (Hotcupboard)

Slow Cooking Oven plus Warming Oven

These ovens are heated by a single element at the rear of the oven cavity. It is operated by a single push ON-OFF button located on the left hand side of the hotcupboard top plate and can be turned ON and OFF when required. These ovens are not cast iron on the interior.

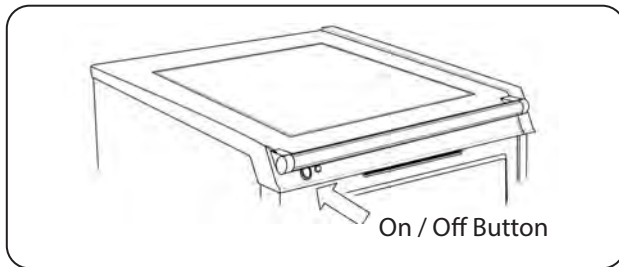

Slow Cooking Oven

This oven has similar characteristics of the simmering oven and should be utilised in a similar manner. It delivers a gentler convected heat making it better suited for longer cooking times especially for overnight cooking, for example rich fruit cakes and celebration cakes. The cooking of meringues may also be better suited for this oven.

NOTE: These ovens vent into the room, mechanical venting to the outside is not available.

Points to remember when Slow Cooking:

- Pre-heat the oven for 30 minutes before starting to cook.
- Bring casseroles, soups etc to the boil on the hob and start meat in the roasting oven, before placing in the slow cooking oven.
- Make sure that casseroles have sufficient liquid, particularly when cooking over a long period.
- Use lids on casseroles or foil to cover food whilst it is cooking to retain moisture.
- Make sure all dishes will fit into the oven before preparing food.
- Make sure that meat and poultry is piping hot before eating and reaches 75°C internal temperature.
- Always thaw frozen food completely before cooking.

You can also produce crisp, white meringues cooked in the slow cooking oven.

Timings for cooking in the slow cooking oven will depend upon the temperature, quantity and type of dish you are cooking, as a guide for casseroles, a minimum of 2 hours cooking time is recommended.

Keep an eye on the food until you are familiar with the oven.

The slow cooking oven can be described as a continuation oven. It continues to cook food that has been brought up to heat elsewhere on the cooker with the exception of meringues which are dried out rather than 'cooked'.

Caring & cleaning

Regular cleaning is recommended. For easier cleaning, wipe up spillages immediately.

On enamelled surfaces use a cleaner that is approved for use on vitreous enamel.

Outside of cooker		
Part	Finish	Recommended Cleaning Method
Doors	Toughened glass	Hot soapy water and soft cloth
Front	Paint	Hot soapy water and soft cloth
Plinth	Paint	Hot soapy water and soft cloth
Chrome handle rail and door handles	Chromed aluminum	Hot soapy water and soft cloth
Hotplate lid cover	Stainless steel	Damp cloth - the AGA e-cloths are excellent AGA Stainless Steel and Chrome Cleaner are recommended to keep the insulated covers clean and shining
Hotplate surround and handle	Enamel and stainless steel	Hot soapy water and soft cloth Enamel: approved cleaner Stainless steel: AGA Stainless Steel and Chrome Cleaner are recommended to keep the insulated covers clean and shining
Hotplate lid – inner liner Use an AGA splash shield to keep lining free of fat splashes	Aluminum	Hot soapy water and soft cloth after cooking Clean the linings when they are cool, and the cooker is off. Clean marked linings with hot soapy water and/or a cream cleanser when the hotplates are cold . A soapy soap- impregnated pad can be used in a circular motion, this might create circular marks, but these are reduced and the surface becomes shinier each time of use. DO NOT use excessive water and make sure the linings are dry before closing the covers.

Hotplate/hob		
Part	Finish	Recommended Cleaning Method
Top plate (hotplate)	Cast iron - pan support	Damp cloth - mop up spills as soon as they happen.
Hotspot	Cast iron	The hotplate is easy to take care for, and regular maintenance will ensure long-life. Should the hotplate become soiled; remove burnt off spills with a sponge, cloth, scouring pad or wire brush. Rinse off detergents or cleaning agents thoroughly. Remember to switch on the plates for a few minutes to dry them after cleaning. Every now and then, apply a thin coating of cooking oil when the hotplates are cold.
Induction hob	Toughened glass	Hot soapy water, cream cleaner and scourer if needed
Control panel	Toughened glass	Warm soapy water and soft cloth

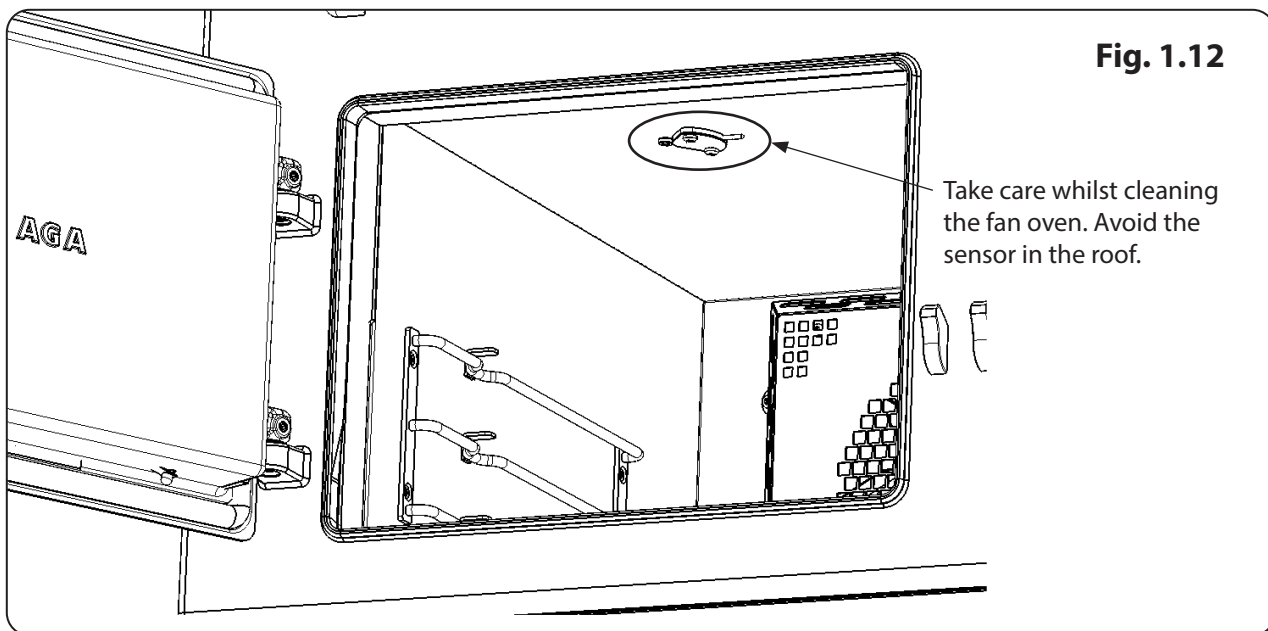

Ovens and Grill		
Part	Finish	Recommended Cleaning Method
Cast ovens	Cast iron anneal grip	<p>The cast iron ovens help to keep themselves clean, they merely need to be brushed out occasionally with the wire brush supplied.</p> <p>Remember to always switch the ovens on, to dry them out after cleaning.</p> <p>Heating up of the ovens periodically, will help burn off any cooking deposits to aid cleaning within the ovens.</p> <p>DO NOT allow contact with the grill element in the top of the top cast oven</p>
Removable door liners	Stainless steel	<p>Hot soapy water, cream cleaner and scourer if needed or in the dishwasher.</p> <p>To remove the door liners, depress the two spring buttons on the sides of the door liner and pull top edge forward. N.B. due to the tight fit of the door liner it may be necessary to gently prise the top edge. If this is the case loosen the top corners one at a time. Depress the relevant button spring while gently lifting the corner slightly with a small flat bladed screwdriver (or similar tool) Fig A. Repeat on the opposite top corner, then pull the liner forward.</p> <p>To refit locate the bottom edge first and then push back into position until the button springs have locked in place Fig B.</p>

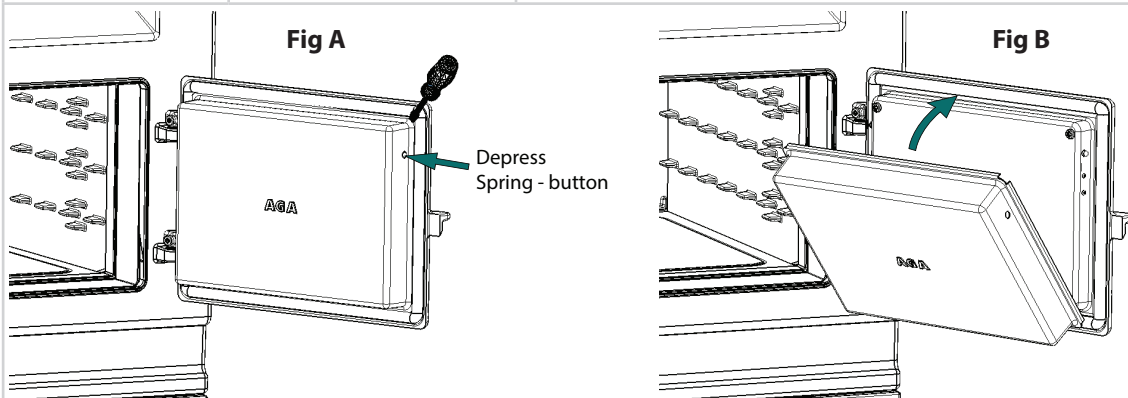

Ovens and Grill		
Fan oven	Enamel	Any approved enamel cleaner. Take care when cleaning since the oven sensor is in the roof of the oven Fig. 1.12
Oven shelves	Stainless steel	Any oven interior cleaner suitable for chrome and/or soap lled pad. Can be dishwashed
Roasting tins	Enamel	Hot soapy water, soaking if necessary. A nylon scouring pad can also be used. They may also be cleaned in the dishwasher, but with constant use, the enamelled nish will become dull in appearance. DO NOT use caustic cleaners or oven cleaners

The hotplate and cast ovens are made from cast iron, and are very durable, but they will rust if surface moisture is left on them.

Specialist cleaners, e-cloths and Splash shields can be obtained from your AGA Specialist or online at www.agacookshop.co.uk.

DO NOT IMMERSE THE DOORS IN WATER AS THEY ARE PACKED WITH INSULATING MATERIAL WHICH WILL BE DAMAGED BY EXCESSIVE MOISTURE.

DO NOT PUT OVEN DOORS IN A DISHWASHER.

Ovens

The cast iron ovens help to keep themselves clean, they merely need to be brushed out occasionally with the wire brush supplied.

The ovens are made from cast iron, and are very durable, but they will rust if surface moisture is left on them regularly. Remember to always switch the ovens on, to dry them out after cleaning. This is done by leaving them to heat up until the green light on the control panel turns solid.

Heating up of the ovens periodically, will help burn off any cooking deposits to aid cleaning within the ovens.

Hotplate

The hotplate is easy to care for, and regular maintenance will ensure long-life. Should the hotplate become soiled, use a sponge, cloth, scouring pad or wire brush to remove burnt-on spills. Rinse off detergents or cleaning agents thoroughly.

The hotplate is made from cast iron, and are very durable, but they will rust if surface moisture is left on them regularly.

Remember to switch on the plate for a few minutes to dry them after cleaning. Every now and then, apply a thin coating of cooking oil when the hotplate is cold.

Roasting Tins

The enamelled roasting tins supplied with the AGA eR7i should be cleaned in hot soapy water, soaking if necessary. A nylon scouring pad can also be used. They may also be cleaned in the dishwasher, but with constant use, the enamelled nish will become dull in appearance.

DO NOT use caustic cleaners or oven cleaners.

Important

We recommend Vitreous Enamel Association approved cleaners for cleaning the vitreous enamelled surfaces of this product.

They are unsuitable for use on: chrome and stainless steel components, including the insulating covers, hand-rails and their brackets.

Fitting & removal of the cast heat storage oven shelves

When using the oven shelves for the first time follow **Fig. 1.13**, **Fig. 1.14**, **Fig. 1.15**, **Fig. 1.16**.

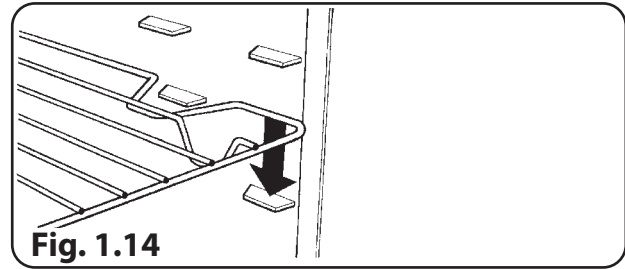
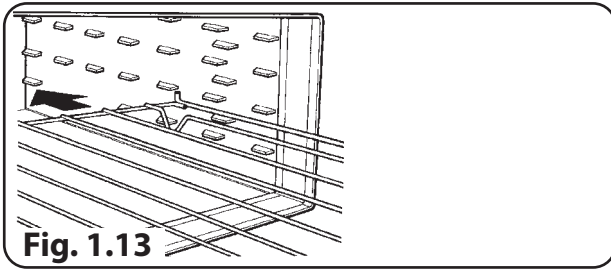

Removal of the cast heat storage oven shelves

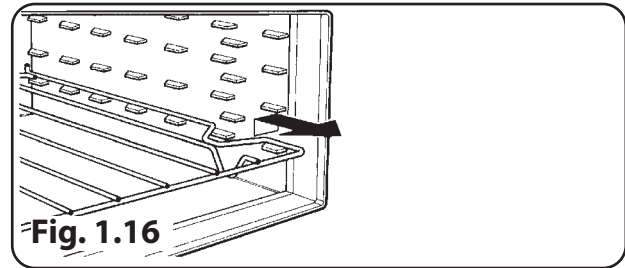
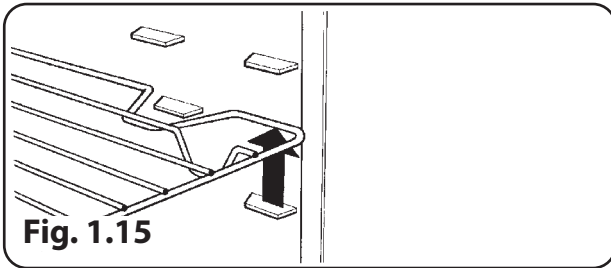

Fitting & removal of fan oven shelves

These shelves are designed to slide out Note: Shelf slides out to stop position.

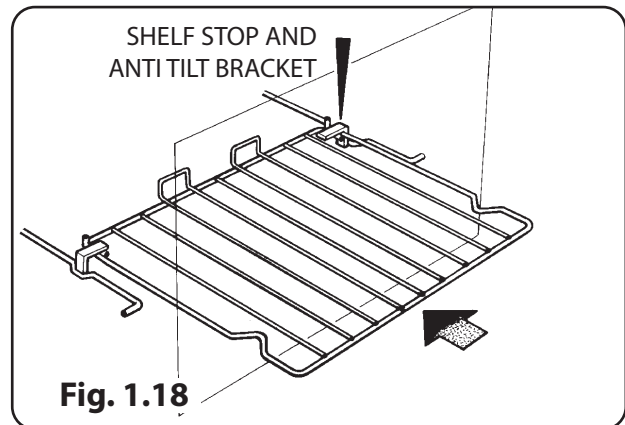
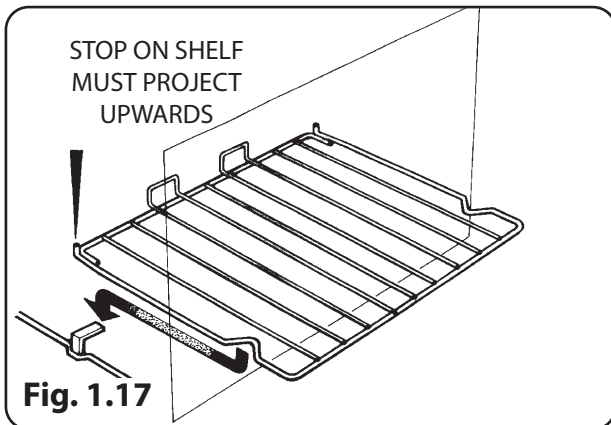

Servicing & warranty

- Your AGA does not need to be regularly serviced.
- Fans may need periodic replacement.
- In the event of requiring maintenance, please call AGA Service or your authorised distributor.
- Your appliance **MUST** only be maintained and installed by a qualified engineer, AGA engineer or an authorised distributor.
- **DO NOT** alter or modify the appliance.

The appliance warranty does not cover Commercial use (see separate Warranty book provided for further details).

Error codes

In the unlikely event an error occurs with your AGA eR7i cooker, error codes may be displayed on your handset, for example:

3.11

Please provide AGA Service with this information. It will assist the service engineer with diagnosing your fault.

Serial number

Make a note of your AGA eR7i Serial Number when it is being installed. The serial number can be found behind the magnetic plinth cover.

Health & safety

Consumer Protection

As a responsible manufacturer, we take care to make sure that our products are designed and constructed to meet the required safety standards when properly installed and used.

 **This appliance is not intended for use by persons (including children) with reduced physical, sensory or mental capabilities, or lack of experience and knowledge, unless they have been given supervision or instruction concerning use of the appliance by a person responsible for their safety.**

 **Children should be supervised to ensure that they do not play with the appliance.**

 **IMPORTANT NOTICE: PLEASE READ THE ACCOMPANYING WARRANTY**

 **Any alteration that is not approved by AGA could invalidate the approval of the appliance, operation of the warranty and could also affect your statutory rights.**

APPLIANCE

 **YOUNG CHILDREN SHOULD BE KEPT AWAY FROM THE APPLIANCE AS SURFACES CAN BECOME HOT TO TOUCH.**

- **DO NOT** hang clothes on the left hand side of the AGA hand-rail. The electrical controls are behind the top left hand door, blocking the air vent can cause excessive control temperatures, and will prevent easy access to the controls.

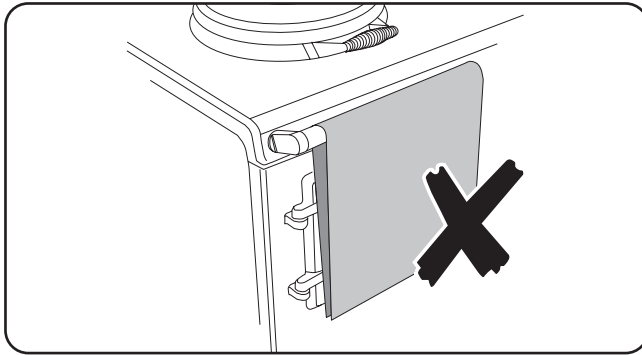

- ⚠ **When the oven(s) are on DO NOT leave any oven door open for long periods, this will affect the temperature of the oven and may allow controls to become hot.**
- ⚠ **A little smoke and some odour may be emitted when the appliance is first switched on. This is normal and harmless (from oven lagging and starch binder on the element insulation) and will cease after a short period of use.**

Deep fat frying

IMPORTANT

- Use a deep pan.
- Never fill the pan more than one-third full of fat or oil.
- Never use a lid on the pan.
- Important: Oil is a fire risk, do not leave pans containing oil unattended.
- In the event of a fire, cover the pan with a lid and turn OFF the appliance.

Smother the flames on the hob, preferably with a fire blanket, rather than attempting to remove the pan to the outside.

Burns and injuries are caused, almost invariably, by picking up the burning pan to carry it outside.



AGA CLOUD, THE FIRST AGA RECIPE APP

Download **AGA Cloud** to view a host of delicious step-by-step recipes tailored to your AGA appliance.

Available only in the United Kingdom and Ireland.



With AGA Rangemaster's policy of continuous product improvement, the Company reserves the right to change specifications and make modifications to the appliances described and illustrated at any time.



Manufactured By

AGA Rangemaster

Station Road

Ketley Telford

Shropshire TF1 5AQ

England

www.agaliving.com

www.agacookshop.co.uk

